

Gunnebo SpeedStile FL

BA/EV Series

Flap Leaf Speed Gate for Internal Installation

GUNNEBO[®]

Flap Leaf Speed Gate for Internal Installation

Motorised flap leaves

Transparent design and effective barrier performance in a small footprint. For sites where limited space is required and aesthetics are still a must. Quiet and smooth in operation, this Gunnebo Speed Gate is available in the BA finish with anodised aluminium silver (black for EV finish) colour lid. Applied finish selection is available as option. Both versions are available in two lengths, and with a selection of leaves widths and heights and many other customisation options.

Applications include Leisure, Government, Finance, Banking, Retail, Telecommunications, Information Technology, Publishing, Education...

Security Features

Fraud Detection through sophisticated and proven algorithm

Intrusion
Tailgating
Piggybacking
Wrong way direction
Leave aisle timeout

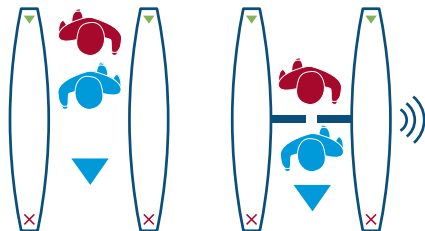

Tailgating and piggybacking detection

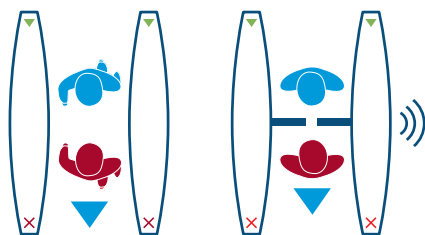

Wrong way and intrusion detection

Mode of Operation

Flap Leaves

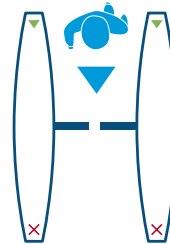

Normally Closed

Passage in one or both directions is electronically controlled. On receiving a signal from the access control system, or remote control, the flap leaves open (Normally Closed NC). If an unauthorised person

tries to tailgate or attempts to enter from the opposite direction, the in-built alarm system is activated. If within the pre-set timeout no passage has occurred, the lane will close and reset.

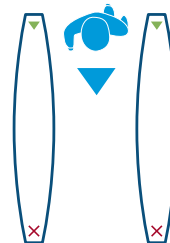

Normally Open

Normally Open N/O provides an open walkway in rest position and will only close at unauthorised entry or tailgating attempts.

Illuminated symbols

Steady light=Normal use. Flashing light=Alarm conditions.



Green Arrow

Steady: Authorised use or designated free passage Proceed through the unit.

Flashing: Emergency/Fire exit.

Red Cross

Steady: Unit in use or no passage. Passage not authorised.

Flashing: Alarm, fraudulent condition or technical alarm.

Available optional 50mm diameter LED display pictogram and LED way-mode indicators flush mounted within the lid surface, with illuminated symbols.



Safety Features

Safety force sensing
Safety light curtain (option)
Accurate presence sensing
Emitter/receiver infrared sensors technology
Logic voltage 24 Vac
Voltage free contact input for Fire Alarm fail state
Fail-Safe manual push opening
Fail-Safe via battery back-up opening (option)
Wide walkway for wheel chair or easier access
Accompanied wheelchair or child passage management

For security and safety reasons children must be supervised by an adult at all times in the vicinity of an active lane. Any child being escorted through the lane must always precede the accompanying adult during passage.

Design/Construction

Available versions are the BA with Stainless Steel 304 grade construction and the EV with applied finish on the aluminum lid. Available cabinet design construction (for both versions):

Height: 1.0m/1.2m/1.8m. **Length:** 1925mm/1500mm

Standard passage way 600mm and Wide passage (900mm) available. Available also as Combi – centre cabinet with narrow (600mm) passage in one side and wide (900mm) passage on the other side. For the 1500 mm long version, a reduced passageway is allowed.

In order to create a lane it is necessary to have one right and one left cabinet. To create more than one lane, use one or more centre or combi cabinets. Select cabinets according to the number of lanes and passage width desired.



1. Left 2. Right 3. Centre 4. Left Wide 5. Right Wide
6. Centre Left Wide 7. Centre Right Wide 8. Centre Wide



Two lane configuration comprising of 1N°L, 1N°C and 1N°R cabinets (left), and Two lane configuration comprising of N°1 LW, 1N°CLW and 1N°R cabinet (right).

Finishes

BA and EV versions share the same chassis, plinth and end leg posts and rotor column finishing in 304 grade stainless steel and toughened laminated glass inlay 13.5mm thick.

Standard finishes for top lid: anodised aluminium silver for BA and anodised aluminium black for EV.

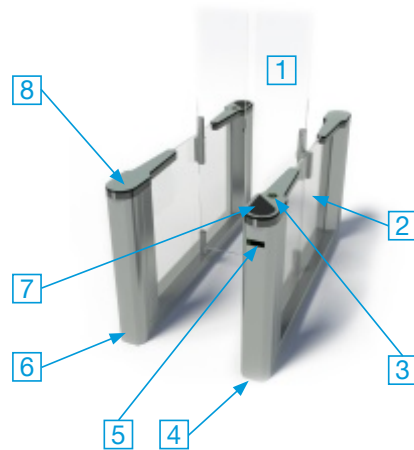

1. Flap Leaves. 2. Glass inlay. 3. Pictogram. 4. Plinth.
5. LED way mode indicator. 6. End Leg. 7. Card reader integration. 8. Lid.

Optional finishes for top lid

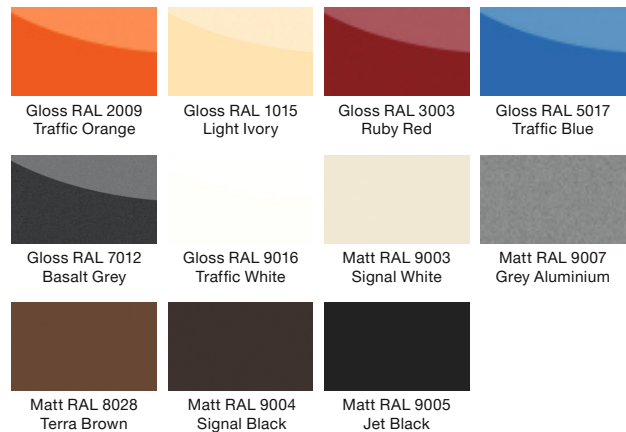

Applied finishes for top lid

White or Black Carbon fibre effect, Dark Mahogany effect or Light Maple effect

Options & Accessories

Alternative finishes and materials	Card reader integration
LED way mode indicator	Battery back-up
Pictogram	Remote control systems
Light curtain safety kit	

Access Specifications











Flow rates by type of reader¹

Insertion type	Swipe type	Proximity type
20 Passages per minute	30 Passages per minute	40 Passages per minute

1. Approximate figures.

Accessibility for Standard (600mm) vs. Wide (900mm) models

Plain dot indicates the functionality is implemented, empty dot indicates some limitations, no dot indicates not available. Emergency egress² functionality implemented as standard.

											
600mm	•	•	•	•	•	•	○	○			○
900mm	•	•	•	•	•	•	○	○	•	•	•

Disabled Access: 900mm net passage way and algorithm able to manage wheelchair access.
 2. In the event of a power failure the flap leaves will remain in the current position.

Electrical Data & Conditions of Use

Power Supply	Power Rating	Power Rating	Battery Back-up	Fire Signal	Operating Temperature	IP Rating	Noise Level
230Vac 50Hz ¹	120VA Stand by	300VA In operation	For 1 last operating cycle ²	Input for voltage free contact	+5°C to + 40°C RH 95% No condensing	IP20	Less than 55dB ³

1. 115Vac 60Hz also available on demand. 2. Option 3. Note: Average background noise in office environment is 50-55dB

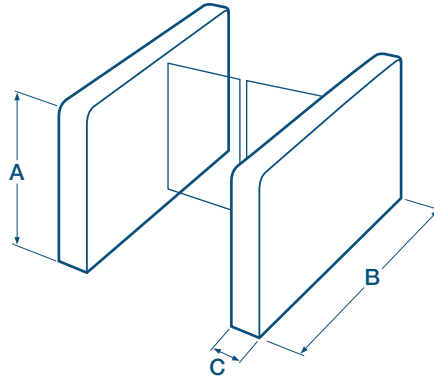

Dimensions & Weights

	Overall Height	Passage Width ¹	A Cabinet Height	B Cabinet Length	C Cabinet Width	Weight (kg) Side Cabinet	Weight (kg) Centre Cabinet
Standard 1000	1000	600	1000	1500/1925	170	135	150
Wide 1000	1000	900	1000	1500/1925	170	137	154
Standard 1200	1200	600	1000	1500/1925	170	140	160
Wide 1200	1200	900	1000	1500/1925	170	142	164
Standard 1800	1800	600	1000	1500/1925	170	147	174
Wide 1800	1800	900	1000	1500/1925	170	149	178

Dimensions in (mm). Weight net (kg). Might require lifting equipment. For details refer to installation detail drawings.

1. 1500mm long cabinet requires an additional 30mm for standard 600mm lane width or an additional 80mm for wide 900mm lane width, to obtain the 600mm or 900mm passageway, otherwise the passageway might be accordingly reduced depending on local regulations (min 50mm gap).

Installation & Maintenance

Product Delivery	Application	Site Preparation ¹	Cabling & Conduits ²	Control Board Location	Systems Integration ⁵	Systems Integration ⁵	Maintenance Access	MTTR ³	MCBF ⁴
Fully assembled	Indoor	Flat & level finished floor +/- 5mm	Through the ground	In master SpeedStile cabinet	27 digital interface I/O RS232 RS485	Settings programmable via parameters	Through end leg panel	Less than 30 minutes	4 million (5 million if NO)

1. Bolting depth MIN 70mm, concrete MIN fckcube 30N/mm² resistance, MIN 2000 mm x 500 x 150 mm deep. 2. Running MIN 140mm below finished floor level, should rise MIN 50mm from foundation. 3. Mean time to repair. 4. Mean cycle between failure. 5. Potential free contact for card reader input. New Electronic Platform with in-built RS485 and COMR1 switching interface.

It is the customer's responsibility to ensure the structural integrity and strength of the installation location.

Data provided is for information only, please refer to your usual Gunnebo Customer Service contact in order to prepare the installation site.



Want to see SpeedStile FL BA/EV in full action?
Scan this QR code with your smartphone.
Or search for "SpeedStile FL BA/EV" on YouTube.

Gunnebo SpeedStile FL



Take advantage of our knowledge:
www.gunnebo.com/Entrance-Control

